

Horizon

HCB-2

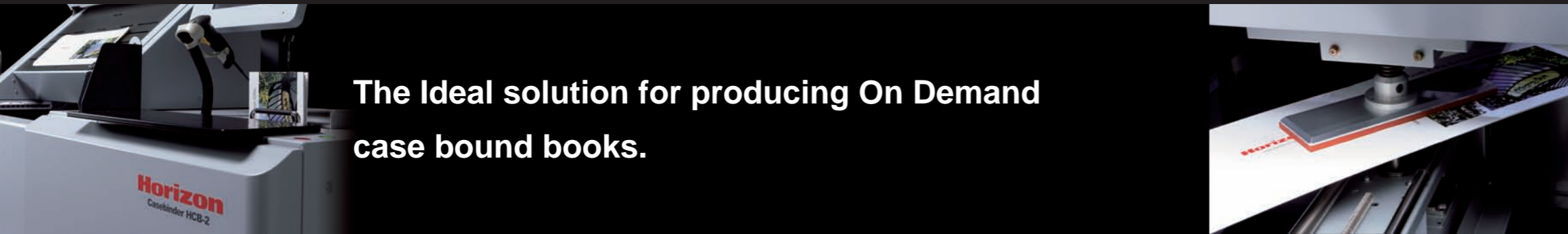

The Ideal solution for producing On Demand case bound books.



Produce professional quality case bound books with a simple process.

Complex case binding steps are simplified with easy touch screen operation and advanced automation.



1 Operation Console

Simple, easy set up and operation through the intuitive touch screen. The setups are automatically completed after inputting the book block size into the touch screen.

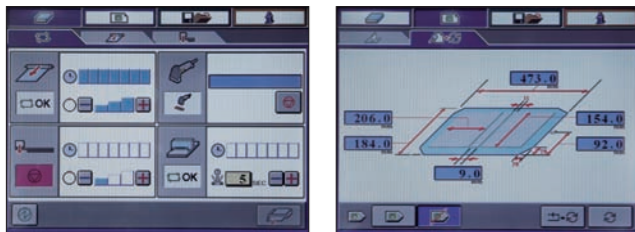

2 Card Board Attachment

The card board positioning guides are set according to the cover size input through the touch screen. A laser light center line is provided for easy center alignment of the cover sheet. An adhesive backed cover sheet is used for efficient and high speed production.

3 Case Making

The cover sheet is automatically wrapped to the board on four sides simply by placing the cover in position.

4 Joint Forming

Casing in and joint forming are performed automatically by simple insertion of the prepared book block.

5 Barcode Verification System HCB-2BC (Option)

Optional barcode verification system ensures the cover and book block match to eliminate costly errors.

6 Heat Press BP-2 (Option)

The case and book block are heat-pressed with optional BP-2 heat press unit to form the complete book.



7 Ergonomic Design

The ergonomic design provides comfortable, convenient operation by placing all necessary consumables and tools within easy reach.

Simple Operation

The control touchscreen is intuitive and all system processes are within arms reach.



Input the dimension of the book block into the touch screen.

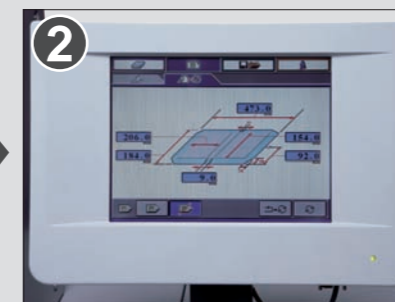

Cover size and card board size are displayed on the screen. Corner cutting tool for covers is provided as an accessory.



Place the card board according to the automatically pre-set positioning guides.



Position the adhesive backed cover using the laser center line for accurate print or image alignment.



Remove the release lining to attach the cover to the card board.

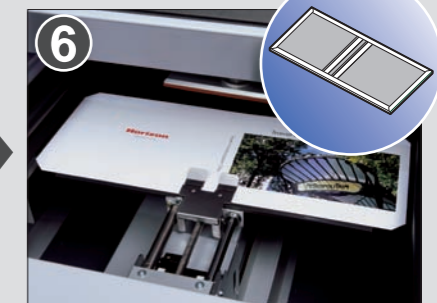

Place the cover into the edge wrapping station, where the four sides of the cover will be wrapped automatically.



Verify a match of the case and book block by scanning the barcode with optional HCB-2BC Barcode verification system.

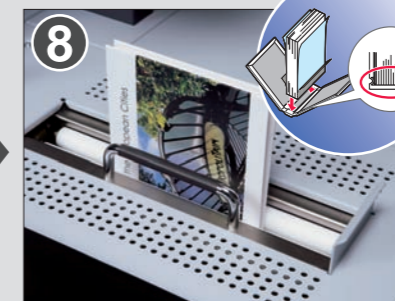

The casing in step forms the hinge and joins the book block with the case. Remove the release lining from the end sheet to attach with the case.

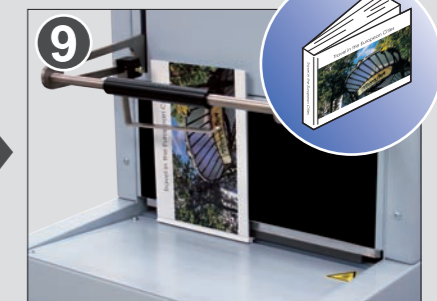

The case is heat-pressed with optional BP-2 heat press unit to complete the book.

HC2-2 Major Specifications

Book Size	Book Block (Top-Bottom x Fore-edge)	Max. 304.8 x 304.8 mm (12" x 12") Min. 133.7 x 136.7 mm (5.27" x 5.39")
	Cover Sheet (Top-Bottom x Fore-edge)	Max. 340.8 x 680.6 mm (13.42" x 26.80") Min. 169.7 x 322.4 mm (6.68" x 12.69")
	Card Board (front & back)	Max. 310.8 x 299.8 mm (12.24" x 11.88") Min. 139.7 x 131.7 mm (5.50" x 5.26")
	Card Board (Spine)	Max. 310.8 x 29 mm (12.24" x 0.98") Min. 139.7 x 7 mm (5.50" x 0.28")
Book Block Thickness	3 to 25 mm (0.12" to 0.98")	
Weight Range	Cover	Adhesive backed cover (104 gsm to 160 gsm)
	Card Board	Chipboard [recommended thickness: 2 mm (0.08")]
Cycle Speed	Max. 130 cycles / hr. (Operation with 2 or more people)	
Voltage/Frequency	Single Phase 115 V, 50/60 Hz	
	Single Phase 230 V, 50 Hz	
Rated Current	115 V, 5.2 A, 50 / 60 Hz	
	230 V, 3.0 A, 50 Hz	
Power Consumption	115 V, 600 W, 50 / 60 Hz	
	230 V, 650 W, 50 Hz	
Heat Output	2,840 kJ (680 kcal)	
Motors	100 W x 1, 10 W x 1	
Heaters	200 W x 2	
Machine Dimensions	1,800(W) x 1,050(D) x 1,536(H) mm (70.9" x 41.4" x 60.3")	
Machine Weight	456 kg (1005.3 lbs.)	

* Production speed varies depending on book size and conditions.

Machine Dimensions [Unit : mm (inch)]

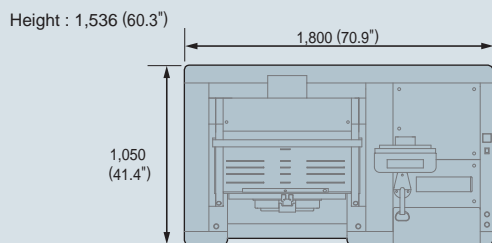

Consumables

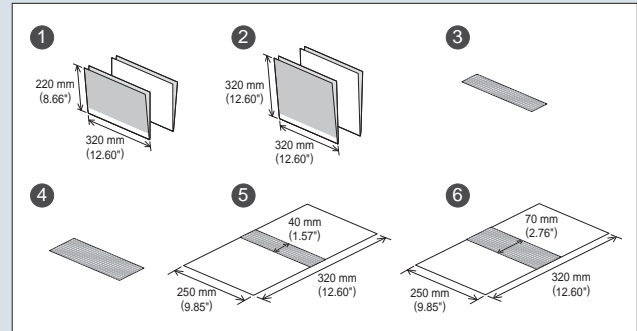

①	End Paper M (M142994)	220 x 320 mm (8.66" x 12.60") Normal Paper 128 gsm Single Fold Adhesive coated on one side	100 sheets
②	End Paper L (M175554)	320 x 320 mm (12.60" x 12.60") Normal Paper 128 gsm Single Fold Adhesive coated on one side	100 sheets
③	Lining 40 (M175551)	40(W) x 320(L) mm (1.57" x 12.60") 0.1mm pre-glued on one side	100 sheets
④	Lining 70 (M175993)	70(W) x 320(L) mm (2.76" x 12.60") 0.1mm pre-glued on one side	100 sheets
⑤	Lining with sheet 40 (M175552)	250 x 320 mm (9.85" x 12.60") 0.1 mm pre-glued on one side (For cover feeding)	100 sheets
⑥	Lining with sheet 70 (M175553)	250 x 320 mm (9.85" x 12.60") 0.1 mm pre-glued on one side (For cover feeding)	100 sheets

*The machine design and specifications are subject to change without any notice.

Book blocks for case bound books can be bound with Horizon Perfect Binders

BQ-160 : Single-Clamp Binder



Glue: EVA

BQ-270C : Single-Clamp Binder



Glue: EVA

BQ-470 : 4-Clamp Binder



Glue: EVA / PUR

	BQ-160	BQ-270C	BQ-470
End Paper M	Yes	Yes	Yes
End Paper L	Yes	Yes	Yes
Lining 40	Yes	Yes*	No
Lining 70	Yes	Yes*	No
Lining with sheet 40	Yes	Yes	Yes
Lining with sheet 70	Yes	Yes	Yes

* Optional KG-270 lining guide is required.



Manufactured by Taiyo Seiki Co., Ltd.

Distributed by

HORIZON INTERNATIONAL, INC.

510 Kuze Ooyabu-cho, Minami-ku, Kyoto, 601-8206, Japan Phone : +81-(0)75-934-6700, Fax : +81-(0)75-934+6708, www.horizon.co.jp